

TO-92 Plastic-Encapsulate Transistors

TRANSISTOR (NPN)

FEATURES

- Power switching applications

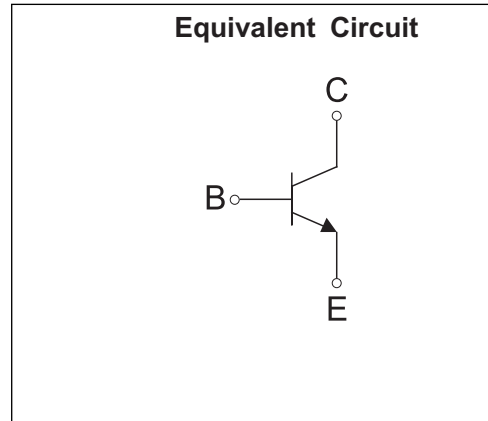

TO-92

- 1. EMITTER
- 2. COLLECTOR
- 3. BASE

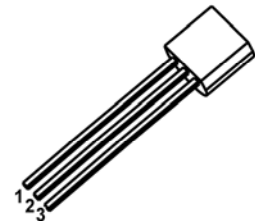

MAXIMUM RATINGS (T_a=25°C unless otherwise noted)

Symbol	Parameter	Value	Unit
V _{CB0}	Collector-Base Voltage	700	V
V _{CEO}	Collector-Emitter Voltage	450	V
V _{EB0}	Emitter-Base Voltage	8	V
I _C	Collector Current -Continuous	0.2	A
P _C	Collector Power Dissipation	0.625	W
T _J , T _{stg}	Operation Junction and Storage Temperature Range	-55 ~ 150	°C

$T_a=25\text{ }^\circ\text{C}$ unless otherwise specified

Parameter	Symbol	Test conditions	Min	Typ	Max	Unit
Collector-base breakdown voltage	$V_{(BR)CBO}$	$I_C=1\text{mA}, I_E=0$	700			V
Collector-emitter breakdown voltage	$V_{(BR)CEO}$	$I_C=1\text{mA}, I_B=0$	450			V
Emitter-base breakdown voltage	$V_{(BR)EBO}$	$I_E=0.1\text{mA}, I_C=0$	8			V
Collector cut-off current	I_{CBO}	$V_{CB}=600\text{V}, I_E=0$			100	μA
Collector cut-off current	I_{CEO}	$V_{CE}=400\text{V}, I_B=0$			100	μA
Emitter cut-off current	I_{EBO}	$V_{EB}=7\text{V}, I_C=0$			100	μA
DC current gain	$h_{FE(1)}$	$V_{CE}=20\text{V}, I_C=20\text{mA}$	14		29	
	$h_{FE(2)}$	$V_{CE}=10\text{V}, I_C=0.25\text{mA}$	5			
	$h_{FE(3)}$	$V_{CE}=5\text{V}, I_C=0.5\text{A}$	1			
Collector-emitter saturation voltage	$V_{CE(sat)}$	$I_C=50\text{mA}, I_B=10\text{mA}$			0.4	V
Base-emitter saturation voltage	$V_{BE(sat)}$	$I_C=50\text{mA}, I_B=10\text{mA}$			1.1	V
Transition frequency	f_T	$V_{CE}=20\text{V}, I_C=20\text{mA}, f=1\text{MHz}$	8			MHz
Rail time	t_r	$I_C=0.1\text{A}$			0.9	μs
Storage time	t_s		1.7		2.9	μs

Static Characteristic

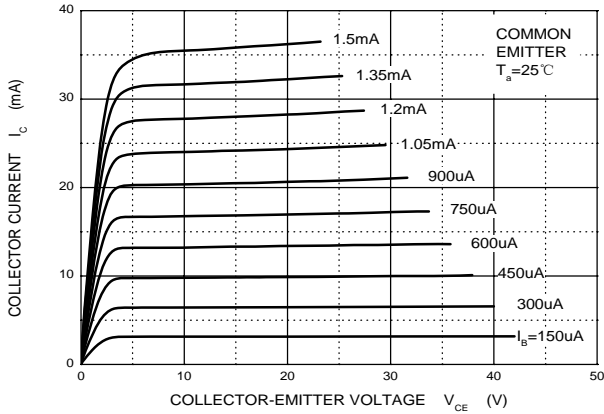

h_{FE} — I_c

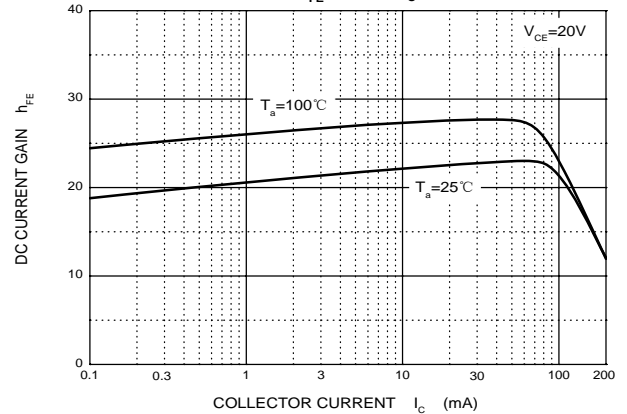

V_{CEsat} — I_c

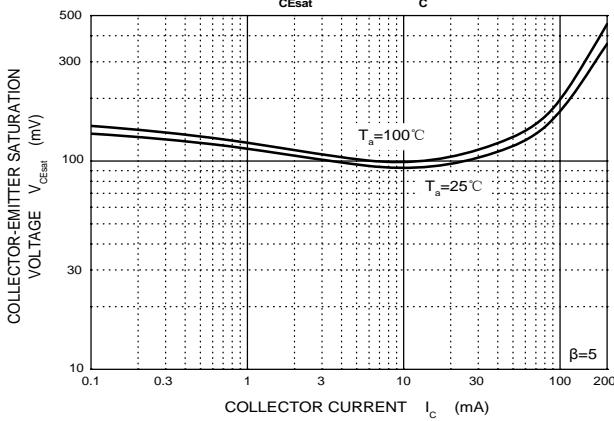

V_{BEsat} — I_c

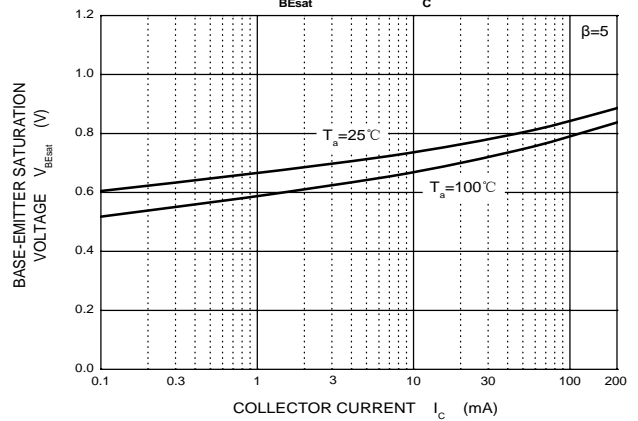

I_c — V_{BE}

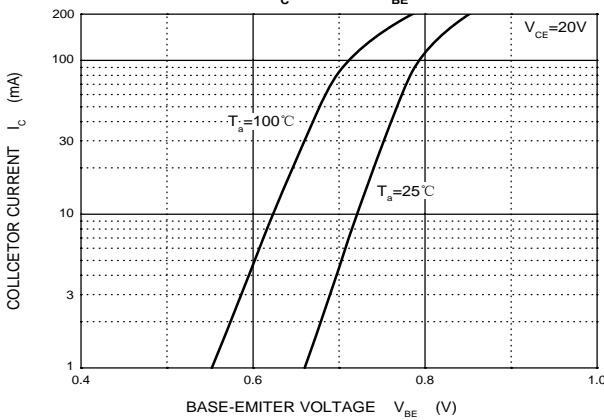

C_{ob}/C_{ib} — V_{CB}/V_{EB}

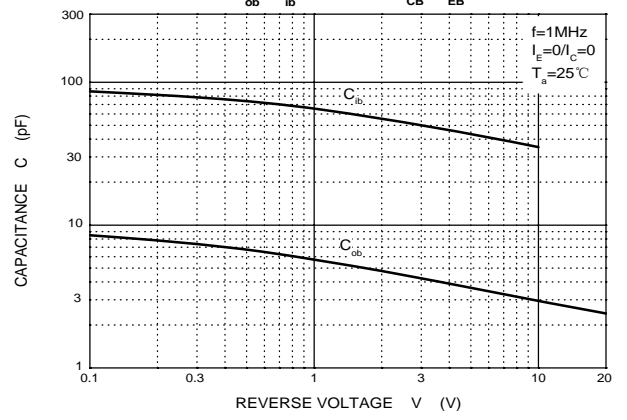

P_c — T_a

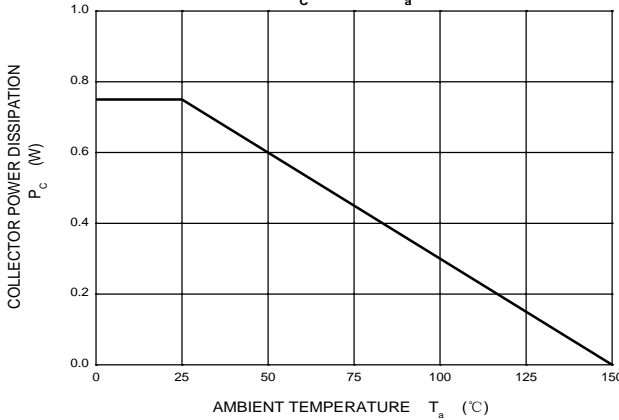

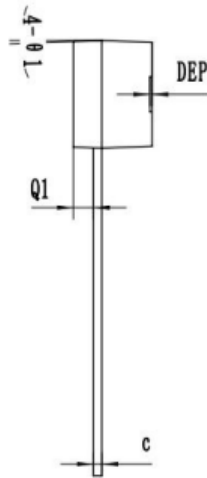
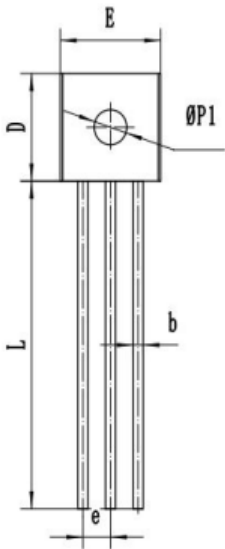

TO-92

SYMBOL	MM		
	MIN	NOM	MAX
*A	3.00	3.25	3.50
A1	2.20	2.30	2.40
*b	0.40	0.45	0.50
*c	0.25	0.30	0.35
*D	4.50	4.60	4.70
*E	4.50	4.60	4.70
*e	1.22	1.27	1.32
*L	14.00	14.30	14.60
R	2.20	2.30	2.40
Q1	0.85	0.90	0.95
θ	3°	5°	7°
Ø1	1°	3°	5°
ØP1	1.40	1.50	1.60
DEP	0.05	0.10	0.20
带*为检验尺寸			

